



# 國倉機械廠有限公司

KUO CHANG MACHINERY CO.,LTD

— SINCE1967 —

國倉機械廠有限公司  
KUO CHANG MACHINERY CO.,LTD

整廠製麵設備專業製造  
NOODLE MAKING MACHINE



# 國倉機械廠有限公司

KUO CHANG MACHINERY CO.,LTD ——— SINCE1967



國倉機械成立於1967年，創辦人王國雄先生，自成立以來即專注在製麵設備的研發設計與製造，豐富的專業經驗，以及對客戶的需求總是細心聆聽，讓客戶以最經濟的成本即可大量生產商品供應市場，為經營者創造最大的獲利空間。因此，國倉機械所生產的製麵設備深受國內外知名食品廠商的肯定與使用。

歷經數十年的努力，本公司為使產品邁向國際化水準，採用最新的電腦構圖設計，配合自動化CNC一貫化作業，輔以精密微電腦自動控制系統，遂能提供穩定的機械性能及人性化的操作介面，尤以彈性的設計變更，深獲客戶的好評與肯定。

- 2000年 獲得 ISO 9001國際品質認證，嚴格要求品質第一。
- 2003年 因應麵食市場潮流，引進國際先進技術，在研發人員捨劣取優、精益求精之下，成功開發出全自動水煮麵生產設備。

Kuo Chang Machinery Co., Ltd. was founded in 1967. Since its establishment, Kuo Chang Co. has been dedicating to design and manufacture the Noodle Making Machines.

Kuo Chang Co. has the professional experience in Noodle Making Machines and most important of all, we listen to our customers carefully. As a result, the Kuo Chang Co. Noodle Making Machines provide our customers to achieve the maximum output with the minimum labor input.

As we have been emphasizing on the quality of our machines, Kuo Chang Co. will continually provide the best performance, modern style and productiveness for our Noodle Making Machines and therefore make our customers achieve the profitability. Those are the reasons why lots of well-known Food Manufacturers are using Kuo Chang Co. Noodle Making Machines.

In an attempt to achieve the goal of providing the highest standard and best quality of Noodle Making Machines, we have been utilizing the latest computer equipment and software in designing the machines. A setup network system is used starting from machine design to CNC automatic precision process.

In some cases, our customers may need to do some modification for the machines to further maximize the output, Kuo Chang Co. will listen to the customers thoroughly as usual, understand their needs and then satisfy them with the best quality.

## 主要產品

• 方便麵全自動生產設備 (袋、碗裝)  
Instant Noodle Production Line (Bag/Cup Type)

• 生麵全自動生產設備  
Automatic Fresh Noodle Production Line

• 煮麵全自動生產設備  
Automatic Cooked Noodle Production Line

• 乾麵 (直麵條) 自動生產設備  
Automatic Dry Noodle (Stick) Production Line

• 蒸乾麵自動生產設備  
Automatic Steam-Dry Noodle Production Line

• 水餃皮 / 雲吞皮全自動生產設備  
Automatic Wheat Flour Skin Production Line

• 真空麵粉攪拌機  
Vacuum Flour Mixer

• 自動捲麵機  
Automatic Roll Noodles Machine

• 擺折機  
Dough Sheet Fold Device

• 牛角捏合機  
Kneader Machine

• 小型製麵機  
KC-230 Fresh Noodle Making Machine

• 薄片機  
Snack Roll Machine

• 殺菌庫 - 四庫設計  
4-Doors Type Pasteurization Oven

• 翻轉鍋  
Turn Over Tank

●日本 Toyo Packen 株式會社三面封自動包裝機 (立式枕包機) 海外代理  
Oversea Agent: Japan Toyo Packen Co., Ltd



# 袋碗方便麵全自動生產設備

AUTOMATIC INSTANT NOODLE PRODUCTION LINE(BAG/CUP TYPE)

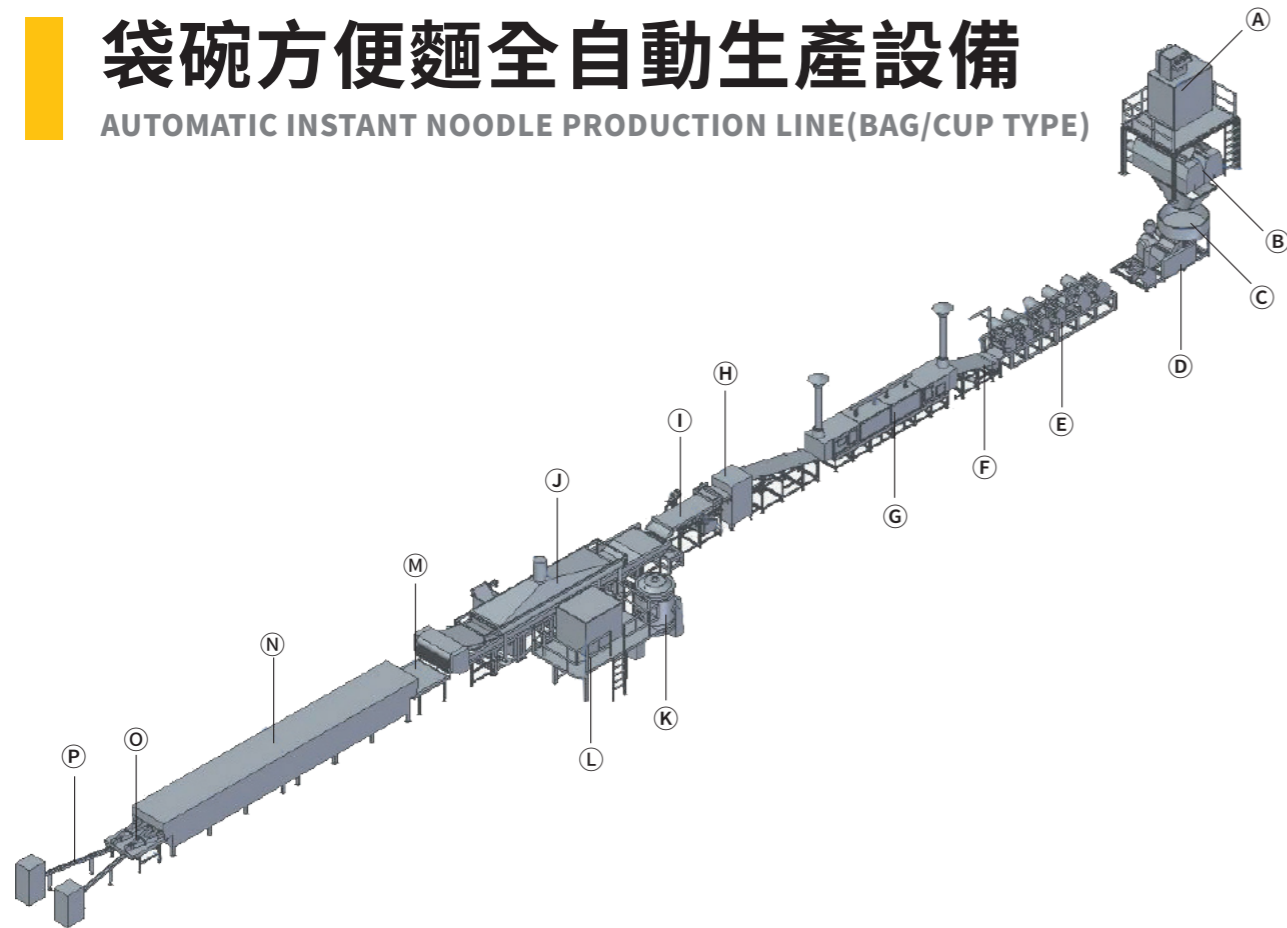

- Ⓐ 吸粉設備 Flour Suction
- Ⓑ 攪拌機 Flour Mixer
- Ⓒ 麵糰進料控制 Dough Inputting Controller Panel
- Ⓓ 複合機 Compound Pressing Machine
- Ⓔ 壓延機 Continuous Pressing Roller
- Ⓕ 切絲 Slicer
- Ⓖ 蒸箱 Steamer
- Ⓗ 定量切斷 Cutting Device
- Ⓘ 調味輸送帶 Distributive Seasoning Conveyor
- Ⓝ 油炸機 Fryer Machine
- Ⓚ 熱交換器 Indirect Heating System
- Ⓛ 儲油桶 Oil Storage Barrel
- Ⓜ 第一整列機 First Settle Machine
- Ⓝ 冷卻機 Cooling Machine
- Ⓞ 第二整列機 Second Settle Machine
- Ⓟ 頂板鏈條輸送帶 Plastic Chain Conveyor

機械型式	600 型分配間接加熱式
產能	100,000 包 /8 小時
滾輪寬度	600MM
蒸煮時間	120 秒
定量切斷	34.6 刀 / 分
調味時間	22 秒
油炸時間	100 秒
冷卻時間	180 秒
油炸加熱器 熱交換量	1,000,000 仟卡 / 小時
蒸氣鍋爐選用 高壓	3.5 噸 / 小時
機械總用電量	160KW

Machine Type	600 Distributing Indirect Heating Type
Capacity	100,000Pcs/8Hrs
Width Of Roller	600MM
Steam Time	120 Sec
Quantitive Cutting	34.6 Cuts/Min
Seasoning Time	22 Sec
Frying Time	100 Sec
Cooling Time	180 Sec
Heat Exchange Of Frying Heater	1,000,000 Kcal/hr
High Pressure Applied For Steam Boiler	3.5 Tons/Hr
Total Power Consumed	160 Kw

# 泡麵線機台介紹

INSTANT NOODLE MACHINE INTRODUCTION



真空麵粉攪拌機  
VACUUM FLOUR MIXER



5/6/7 段式壓延機  
5/6/7 SECTION CONTINUOUS  
PRESSING ROLLER



定量切斷  
CUTTING DEVICE

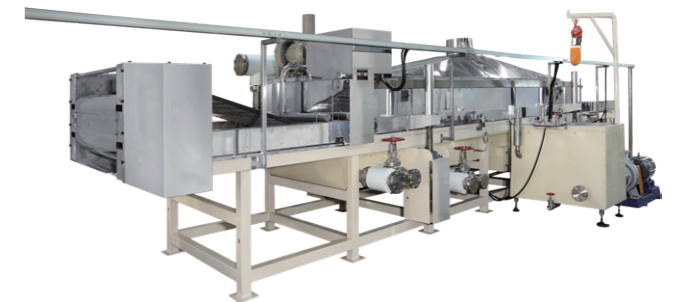

油炸機  
FRYER MACHINE



冷卻機  
COOLING MACHINE



整列機  
SETTLE MACHINE

# 生麵全自動生產設備

AUTOMATIC FRESH NOODLE PRODUCTION LINE

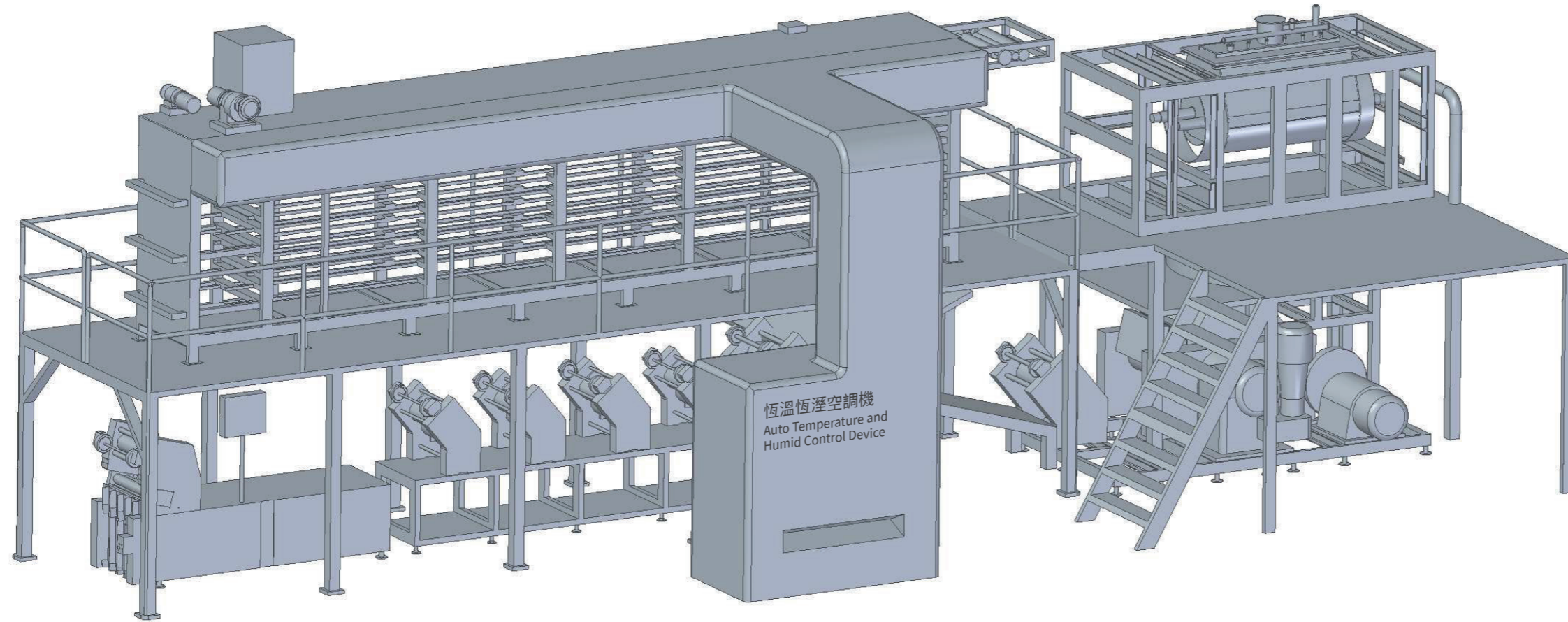

壓延切條機組  
Cutter



連續式熟成室前段  
Continuous Noodle Dough Sheet  
Aging Machine-Front Section



連續式熟成室後段  
Continuous Noodle Dough Sheet  
Aging Machine-Back Section



連續式熟成室內部  
Continuous Noodle Dough Sheet  
Aging Machine-Inside Section

## 生麵設備特色 Specifications Of Fresh Noodle Production Line

- |                     |                                                                                                               |
|---------------------|---------------------------------------------------------------------------------------------------------------|
| · 400~700mmHg 真空度設定 | · Vacuum Capacity 400~700 mmHg                                                                                |
| · 麵糰熟成              | · Waggle Type Noodle Sheet Making                                                                             |
| · 擺摺式麵皮製作           | · Dough Sheet Fold Device                                                                                     |
| · 兩片麵帶複合            | · Two Dough Sheet Compound                                                                                    |
| · 恆溫恆濕麵帶兩面熟成        | · Stick-Type Stainless Continuous Noodle Dough Sheet Aging Machine ( Automatic Temperature And Humid Control) |
| · 單獨傳動壓延速度 / 大小波浪壓延 | · Individual Motor Control By Inverter / Wave Type Roller                                                     |
| · 壓延滾輪單動 / 連動       | · Pressing Roller Individual / Continuous Motor Control By Inverter                                           |
| · 壓延滾輪防夾裝置          | · Pressing Roller Anti-Clamp Device                                                                           |
| · 麵厚數字式顯示           | · Noodle Sheet Thickness Display                                                                              |
| · 麵條長度顯示            | · Noodle Length Display                                                                                       |



真空設備  
Vacuum Equipment



複合機  
Compound Pressing Machine



大波浪壓延機  
Wave Type Continuous Pressing Roller



真空攪拌機  
Vacuum Flour Mixer



麵糰進料控制輸送帶  
Dough Inputting Control Conveyor

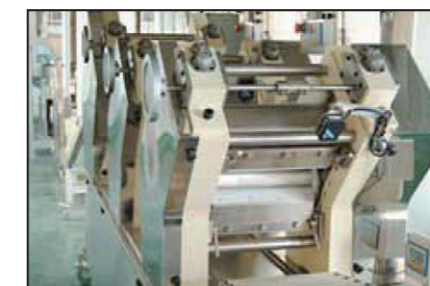

5 段壓延機組  
5-Sections Continuous Pressing Roller

# 煮麵全自動生產設備

AUTOMATIC COOKED NOODLE PRODUCTION LINE

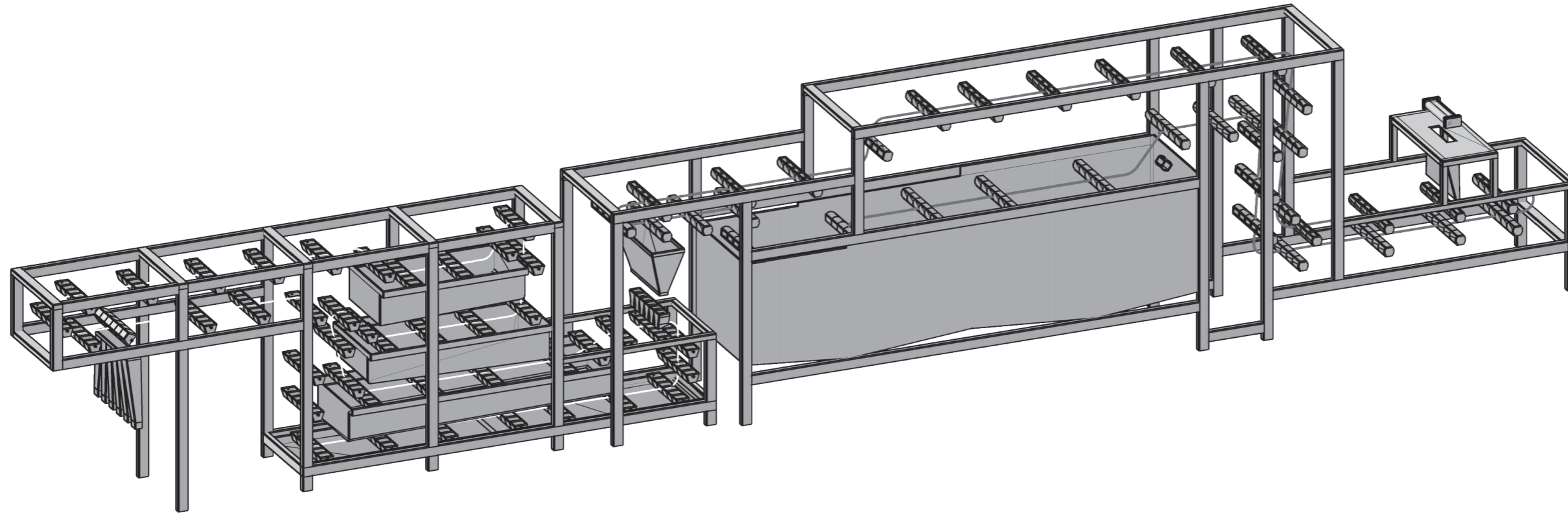

生麵入口  
Fresh Noodle Inlet



三層冷卻槽  
Three-Level Cooling Tank



冷熱分離設計  
Cool and Hot Separated Design



熟麵冷卻入口  
Cooked-Noodle Cooling Inlet

## 煮麵設備特色 SPECIFICATIONS OF COOKED NOODLE PRODUCTION LINE

- |                                                 |                                                                           |
|-------------------------------------------------|---------------------------------------------------------------------------|
| · 烏龍 / 拉麵兩用雙入口                                  | · Udon / Ramen Noodle Two Types Using                                     |
| · 水煮時間最長 12 分鐘                                  | · Maximun Water Cooked Time : 12 Minutes                                  |
| · 間接式加熱 / 自動溫度控制                                | · Indirect Heating / Automatic Temperature Control                        |
| · 槽內熱水溫度均勻循環系統                                  | · Hot Water Inside The Tank-Temperature Cycle System                      |
| · 可設定切刀數 (2 刀 / 1 刀)                            | · Twice Cutting / One Cutting For One Pitch                               |
| · 三層式冷卻槽 (可增加二次冷卻系統)                            | · Cooling Tank : Three-Sections Type (Can Add Second Time Cooling System) |
| · 洗麵裝置                                          | · Noodle-Wash Device                                                      |
| · 殺菌配管                                          | · Sterilization Piping                                                    |
| · 冷熱分離設計                                        | · Cool And Hot Separated Design                                           |
| · 產能 :<br>6000、4000、2000 包 / 每小時<br>(200G / 每包) | · Capacity :<br>6000、4000、2000 Bags / Per hr<br>(200G /Per Bag)           |



白鐵密封軸承  
Stainless Sealed Bearing



冷卻槽內部  
Cooling Tank Inside Section



自動 PH 值感應器  
Automatic PH Value Sensor



自動清洗裝置  
Automatic Clean Device



冰水流量計  
Chilly Water Volume Meter



蒸汽控制閥  
Steam Control Valve

# 真空麵粉攪拌機

VACUUM FLOUR MIXER

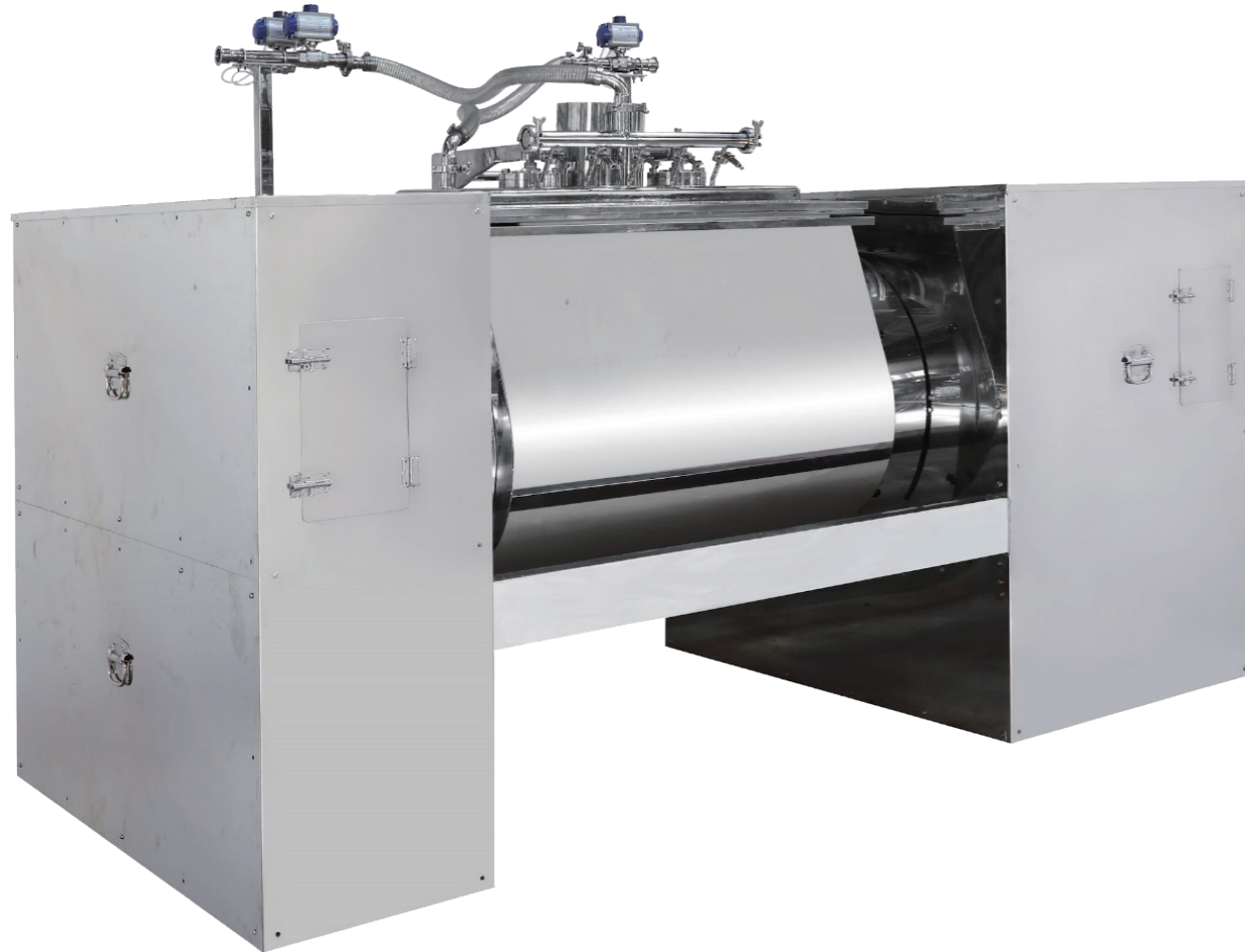

- 最大真空度：700mmHg
- Maximum Vacuum Capacity：700mmHg
- 桶身翻轉下料
- Tanks Turn Down To Discharge Material
- 二段數運轉（高 / 低速）
- Two Speed Drive（High / Low）

# 複合機

COMPOUND PRESSING MACHINE

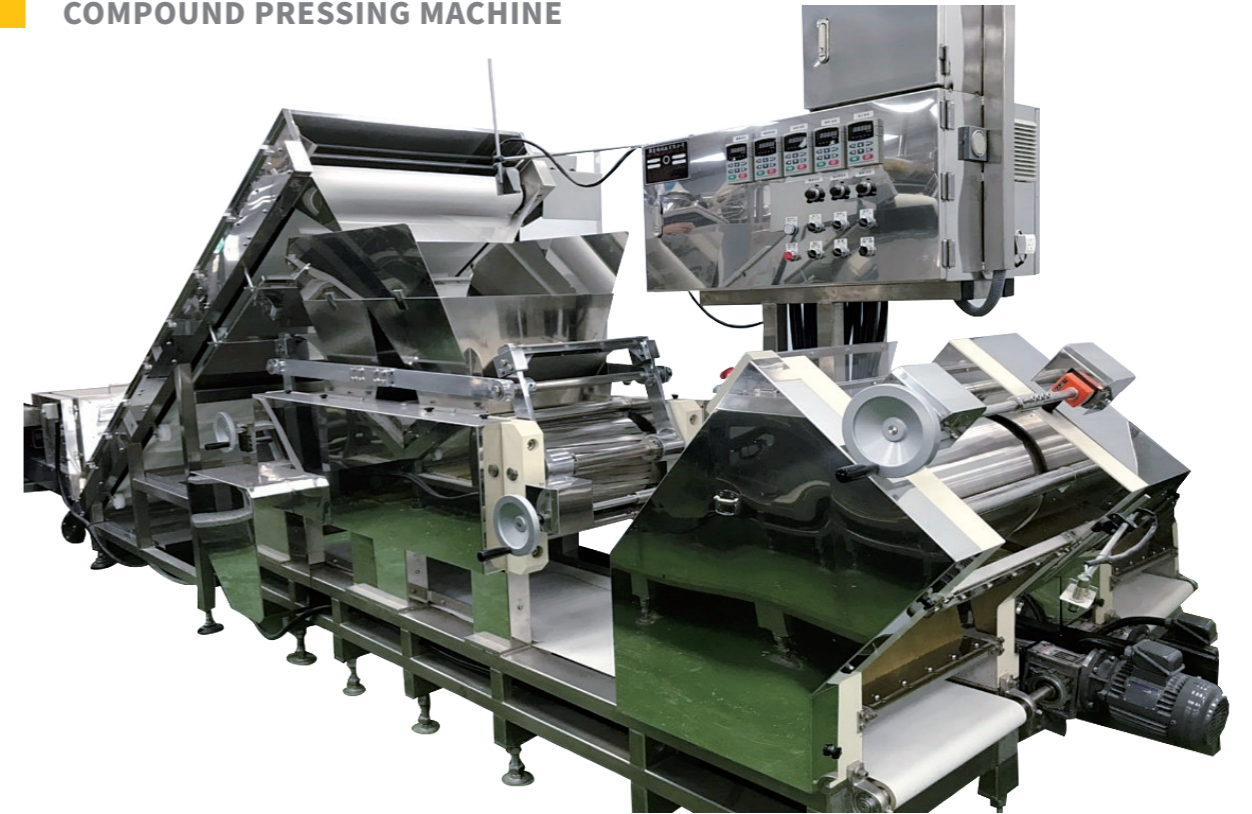

# 壓延機

CONTINUOUS PRESSING ROLLER

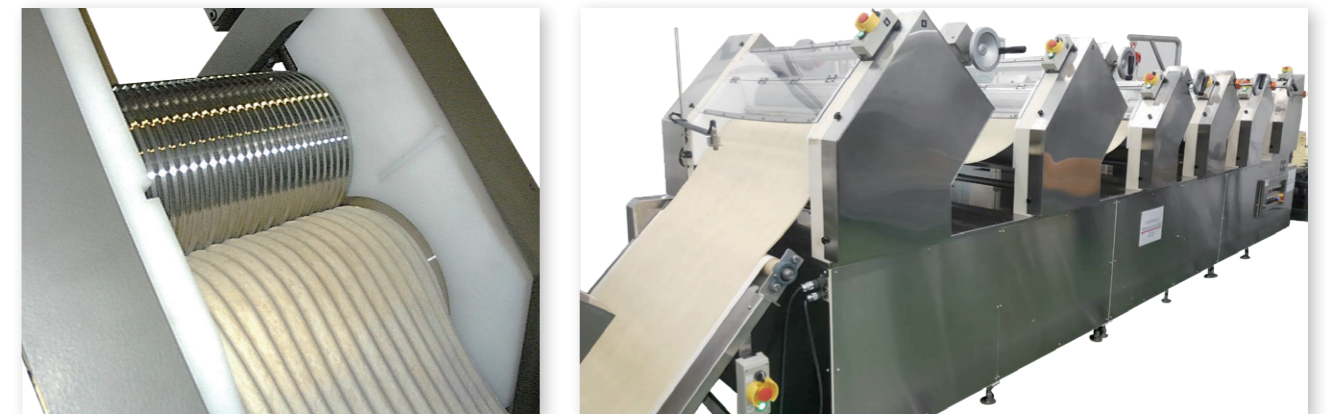

- 單獨傳動 & 自動調整速度
- Independent Motor：Automatic Control Speed With Inverter & Sensor
- 麵厚度顯示
- Noodle Thickness Display
- 4 / 5 / 6 / 7 段可選擇
- Option：4 / 5 / 6 / 7 Sections Continuous Pressing Roller
- 波浪形滾輪（選配）
- Wave Type Rollers（Option）

# 擺摺機

DOUGH SHEET FOLD DEVICE



- |                 |                                          |
|-----------------|------------------------------------------|
| · 直線擺折 / 90 度擺折 | · Straight Line Fold / Right Angle Fold  |
| · 加強麵筋組織        | · Improve The Gluten Structure           |
| · 自動速度追蹤        | · Automatically Track The Speed          |
| · 層數自由控制        | · The Level Can Be Controlled Optionally |

# 麵皮機

WHEAT FLOUR SKIN MACHINE



- |          |                                           |
|----------|-------------------------------------------|
| · 不需排盤   | · No Need To Arrange Trays                |
| · 直接層疊成型 | · Directly Deliver Stack Of Dumpling Skin |

# 自動捲麵機

AUTOMATIC ROLL NOODLE MACHINE



- 可將麵條捲成糰狀方便取用
- Rolling Noodles Automatically And Take Out Easily
- 產速：15-25 回次 / 分
- 15-25 Cycle / Per Minute

# 小型製麵機

KC-230 FRESH NOODLE MAKING MACHINE



- 適合生產量少多樣的麵食產品
- Suitable For Small Batch Noodle Products
- 可製作生產各式生麵條 & 麵皮 (如中式麵條、拉麵、雲吞皮、水餃皮、燒賣皮...等)
- The Machine Can Produce Fresh Noodles And Wheat Flour Skin (Or Dumpling Using)
- 產量：25-45KGS / HR
- Capacity：25-45KGS / HR
- 體積：長 197cm \* 寬 97cm \* 高 165cm
- Machine Size：197(L)\*97(W)\*165(H) CM
- 重量：約 450KGS
- Machine Weight：Around 450KGS
- 馬力：5HP
- Power：5HP



## 計量機

NOODLE SCALE MACHINE

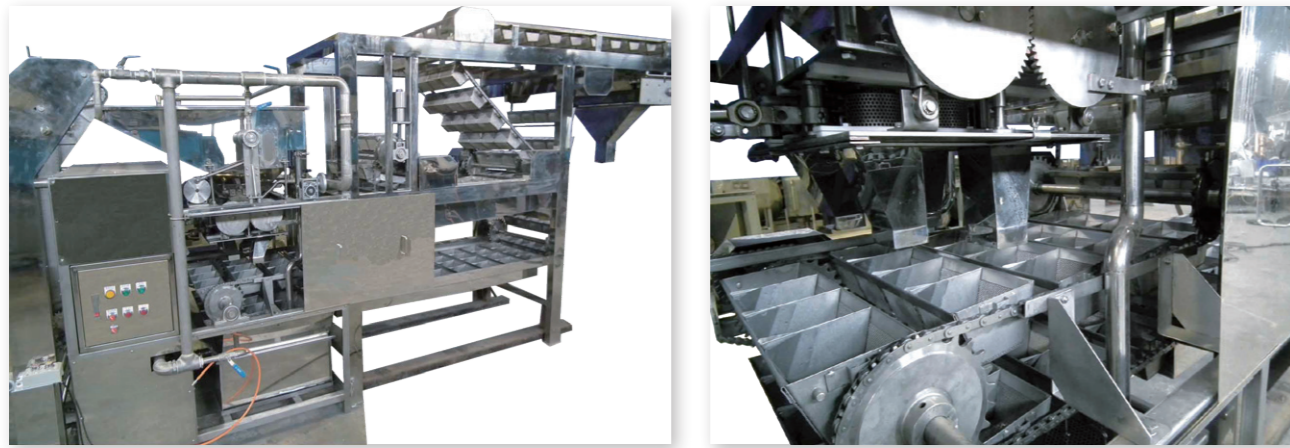

- 計量範圍：120g-280g · Volume Range：120g-280g
- 冷卻 / 浸漬槽設有殺菌配管 · Cooling / Soaking Tank Equipment With Sterilization Piping
- 產能：2000 包 / 每小時 · Capacity：2000 Bags / Per hr

## 翻轉鍋

TURNOVER TANK FOR NOODLE COOKING



- 水煮 / 冷卻時間自由設定 · Water-Cooked / Cool Time Adjustable
- 殺菌配管 · Sterilization Piping
- 培林式轉軸 · Bearing Type Shift

## 薄皮機

SNACK ROLL MACHINE

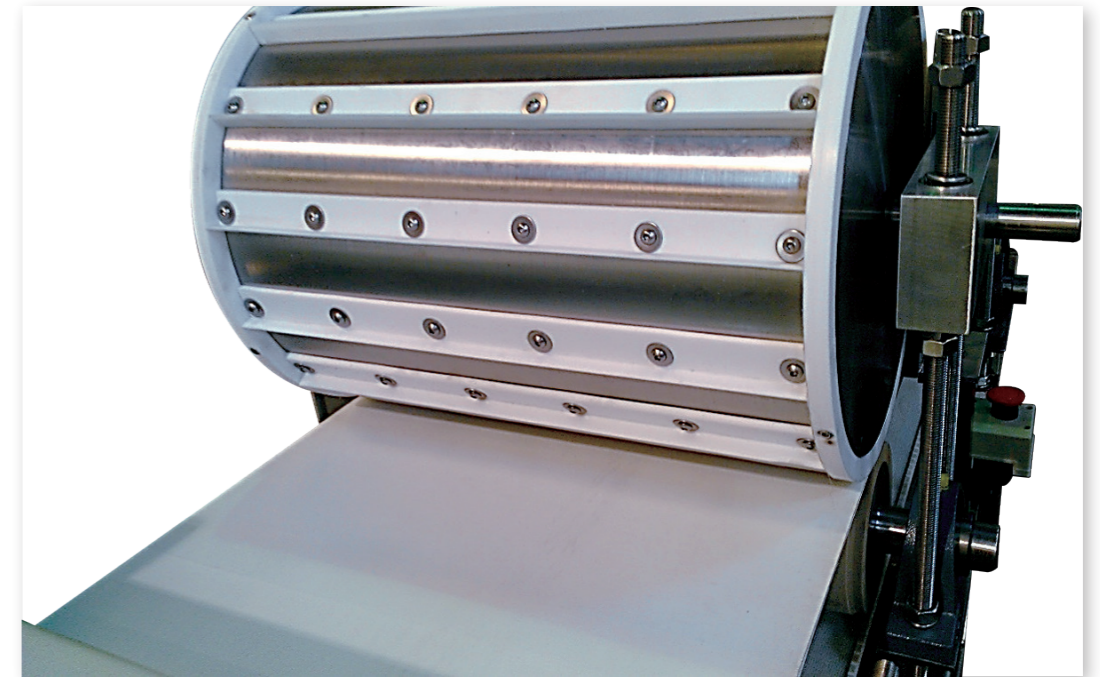

## 牛角捏和機

KNEADER MACHINE

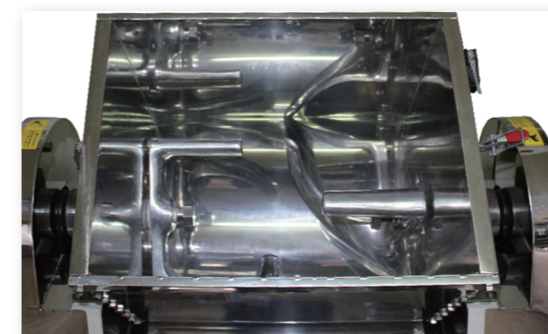

# 客戶實績

## OUR CUSTOMERS

### 亞洲 Asia

#### 台灣地區 Taiwan

- 味丹企業股份有限公司 Vedan Enterprise Corp
- 統一企業股份有限公司 President Enterprise Corp
- 味王股份有限公司 Ve Wong Corporation
- 台灣有明食品股份有限公司 Taiwan Ariake Foods Co.,Ltd
- 聯華實業股份有限公司 Lien Hwa Industrial Crop.
- 台灣鴻德麵食開發股份有限公司 Hong Der Foods Co.,Ltd
- 驛統企業有限公司 E Tong Foods Co.,Ltd
- 傳宗食品有限公司 Legend Master Co.
- 三商餐飲股份有限公司 Mercuries&Associates, Ltd
- 鴻仁製麵食品股份有限公司 Hong Ren Food Industrial Co., LTD
- 優雅食股份有限公司 Oyatsu Company Ltd.
- 智利洋行 Select Chile Imp & Exp . Co
- 旺家實業有限公司 Wangja Inc.
- 台灣通用磨坊股份有限公司 General Mills Taiwan Limited.
- 南僑化學工業股份有限公司 Namchow Chemical Industrial Co.,Ltd
- 樺島商事有限公司 Kabashima Shoji Inc.
- 要建設公司 (台灣城市創造股份有限公司) Machi Group Taiwan Co.,Ltd
- 佳格食品股份有限公司 Standard Foods Corporation
- 萬隆食品廠 Wan Lung Foods Fact
- 香里食品企業有限公司 Shang Lee Foods Co., Ltd
- 源順食品有限公司 Yu Shun Food Co., Ltd.
- 五福星企業有限公司 Shuang Ren Hsu
- 凱亞食品股份有限公司 Kai Ya Food Co., Ltd.

#### 中國大陸 China

- 上海味丹企業有限公司 Shanghai Vedan Foods Co. Ltd.
- 天津頂益國際食品有限公司 Tianjin Tingyi International

#### 澳門 Macau

- 三和食品廠 Sam Wo Food Factory

#### 孟加拉 Bengal

- Bashundhara Food And Beverage Industries Ltd.
- Expert Industrial Solution & Technol Ogies Ltd.
- Kishwan Snacks Ltd.

#### 印度 India

- Itc Group

#### 印尼 Indonesia

- Cv. Pasific Harvest
- Medi City

#### 菲律賓 Philippines

- 快樂蜂集團 Jollibee Foods Corporation
- Manila Bambi Foods Co.
- Q-Phil Products International

#### 日本 Japan

- Frente International Co., LTD
- Y.s. Food Co.

#### 馬來西亞 Malaysia

- Gardenia Bakeries (KL) Sdn Bhd (GBKL)
- Heng Yap Noodle Factory
- Kawan Food Manufacturing Sdn Bhd.
- Muslim Best Marketing (M) Sdn Bhd Makanana (Kuala Lumpur) Sdn Bhd
- Solution Pack Co.,Ltd.
- Vit Makanana (Kuala Lumpur) Sdn Bhd

#### 新加坡 Singapore

- Tat Hui Foods Pte Ltd.
- 五里號私人有限公司 Wu Li Hao Pte Ltd
- 隆原食品貿易私人有限公司 Leong Guan Food Manufacturer Pte Ltd

#### 泰國 Thailand

- Asiansuperior Foods Co.,Ltd.
- 卜峰集團 Charoen Pokphand Group
- Great One Food Products Co.
- Octa Food Co., Ltd.
- Thai Better Foods Co., Ltd.

#### 英國 United Kingdom

- Leecious UK Ltd

#### 加拿大 Canada

- Bedessee Imports Ltd
- Weecn Restaurant Management Ltd.

#### 美國 America

- Anda Usa Co.
- 百利食品 Baily International Inc
- Evergreen Trading
- Shin Shin Foods, Inc
- 云吞食品公司 Wonton Food Corp

#### 南非 South Africa

- Libstar Manufacturing Solutions Ltd.

#### 澳洲 Australia

- Highway Co., Ltd.

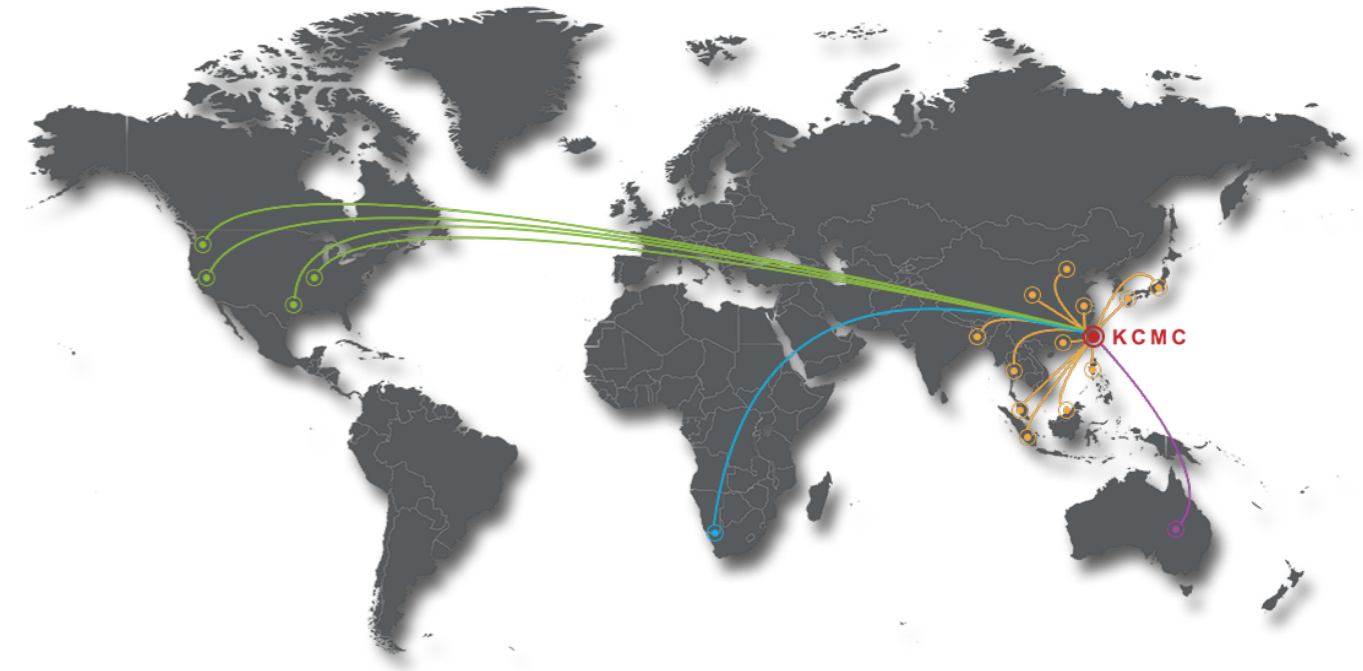

### 亞洲

 味王股份有限公司 Ve Wong Corporation	 台灣有明食品股份有限公司 Taiwan Ariake Foods Co., Ltd.	 佳格食品股份有限公司 Standard Foods Corporation	 香里食品企業有限公司 Shang Lee Foods CO., LTD.	 智利洋行 Select Chile Imp & Exp. Co	 統一企業股份有限公司 President Enterprise	 傳宗食品有限公司 Legend Master Co.
 優雅食股份有限公司 Oyatsu Company LTD.	 樺島商事有限公司 Kabashima Shoji INC.	 鴻仁製麵食品股份有限公司 Hong Ren Food Industrial CO., LTD.	 南僑化學工業股份有限公司 Namchow Chemical Industrial Co., Ltd.	 三商行股份有限公司 Mercuries & Associates, Ltd.	 萬隆食品廠 Wan Lung Foods Fact	 聯華實業股份有限公司 Lien Hwa Industrial Corp.
 台灣鴻德麵食開發股份有限公司 Hong Der Foods Co.,Ltd	 台灣通用磨坊股份有限公司 General Mills Taiwan Limited.	 驛統企業有限公司 E Tong Foods CO., LTD.	 源順食品有限公司 Yu Shun Food CO., LTD.	 旺家實業有限公司 Wangja INC.	 要建設公司 (台灣城市創造股份有限公司) Machi Group Taiwan CO., LTD.	 味丹企業股份有限公司 Vedan Enterprises Corp
 Solution Pack Co.,Ltd.	 Muslim Best Marketing (M) Sdn Bhd	 Kawan Food Manufacturing Sdn Bhd.	 Heng Yap Noodle Factory	 Gardenia Bakeries (KL) Sdn Bhd (GBKL)	 Vit Makanana (Kuala Lumpur) Sdn Bhd	 Itc Group
 Thai Better Foods CO., LTD.	 Octa Food CO., LTD.	 Great One Food Products CO.	 AsianSuperior Foods Co.,Ltd.	 卜峰集團 Charoen Pokphand Group	 Frente International Co., Ltd.	 Y.S. Food Co.
 Medi City	 Cv. Pasific Harvest	 上海味丹企業有限公司 SHANGHAI VEDAN FOODS CO. LTD.	 天津頂益國際食品有限公司 TIANJIN TINGYI INTERNATIONAL	 快樂蜂集團 Jollibee Foods Corporation	 Q-Phil Products International	 Manila Bambi Foods Co.
 三和食品廠 Sam Wo Food Factory	 Tat Hui Foods Pte LTD.	 Kishwan Snacks Ltd.	 Expert Industrial Solution & Technol Ogies Ltd.	 Bashundhara Food And Beverage Industries Ltd.	 Libstar Manufacturing Solutions Ltd.	 Highway Co., LTD.
 Evergreen Trading	 Baily International Inc 百利食品	 Anda Usa Co.	 Wonton Food Corp 云吞食品公司	 Shin Shin Foods, Inc	 南非	 澳洲

### 美國



# 國倉機械廠有限公司

KUO CHANG MACHINERY CO.,LTD

434 台灣台中市龍井區台西南路250號

434 NO.250, TAIXI S.ROAD, LONGJING DISTRICT, TAICHUNG CITY, TAIWAN

TEL : +886-4-2630-0931

FAX : +886-4-2630-3190

E-mail : [kcmc5568@gmail.com](mailto:kcmc5568@gmail.com)

Website : [www.kuo-chang.com.tw](http://www.kuo-chang.com.tw)

